

Comparison of Quartz Crystal Oscillators and Silicon MEMS Oscillators

Contents

Introduction	1
Part 1. “Simply Built” – Manufacturing Differences	2
Part 2. “Simply Built” – Device Architecture Differences	5
Part 3. Lower Jitter	6
Part 4. Lower Power Consumption	8
Part 5. Better Frequency vs. Temperature	10
Part 6. Better Short-Term Frequency Stability.....	11

Introduction

This white paper is an update on SiTime MEMS oscillator technology in response to the Epson white paper “Comparison of Crystal Oscillator and Si-MEMS Oscillators.” The Epson white paper compares quartz oscillators with a SiTime MEMS oscillator that was released in 2011, and a Microchip oscillator that was released in the same timeframe. Since then, SiTime has made groundbreaking progress in MEMS, analog, and systems technologies.

SiTime MEMS oscillators surpassed quartz technology in performance in 2013, and since then, we have been delivering significant technical value to our customers. This white paper includes some performance data on the Epson SG-210*B, which was the Epson device highlighted in the original Epson white paper, but focuses more on high performance differential output oscillators: the SiTime SiT9501 and the EG-2121, a high-performance Epson oscillator that is functionally similar to the SiT9501 but is significantly inferior in performance.

Epson Claim: Quartz crystal oscillators are simply built resulting in lower power and jitter.

Part 1. “Simply Built” - Manufacturing Differences

The “simply built” claim from Epson compares quartz and MEMS oscillator block diagrams, but it is instructive to first compare the manufacturing processes of quartz and MEMS oscillators. Including the quartz resonator and package, together with the integrated circuit (IC) containing the oscillator circuitry, quartz oscillator manufacturing is considerably more complex with a lower level of cleanliness compared to MEMS oscillator manufacturing. A typical quartz process flow is shown in Figure 1 and consists of 23 steps. The key point is that there are significantly more process steps with quartz manufacturing than an all-silicon MEMS process and importantly, four of the quartz process steps must be completed with the package lid open. During these steps (highlighted by the red-outlined rectangle below) the quartz device is especially vulnerable to the introduction of contaminants. Measures are taken to minimize contaminants, but they cannot be eliminated, and this results in accelerated aging and reliability issues.

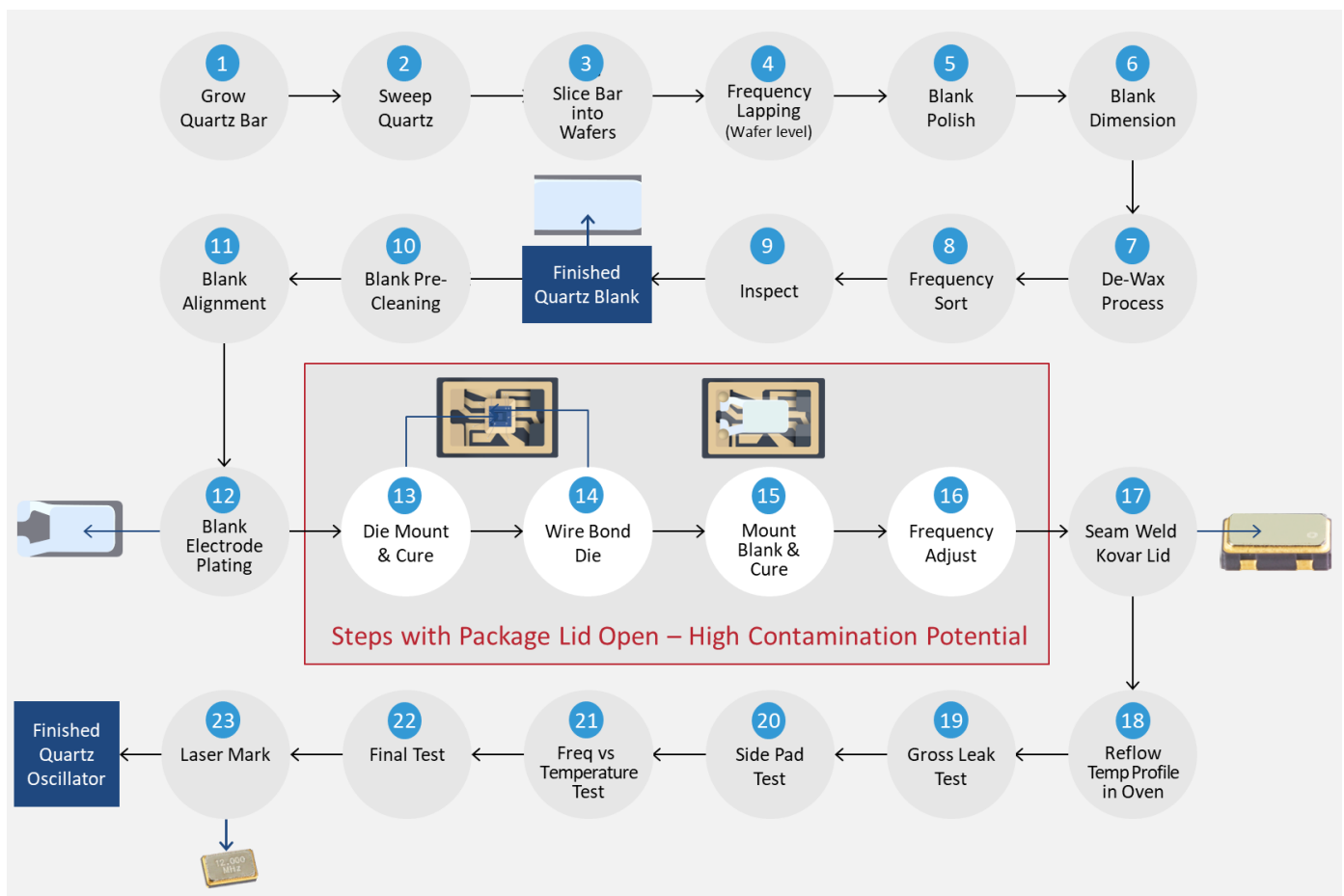

Figure 1. Quartz Manufacturing Process Flow

In contrast, MEMS oscillator manufacturing has only 12 main manufacturing steps and the resonator fabrication steps are performed using an ultra-clean semiconductor wafer process characteristic of semiconductor deep sub-micron wafer fabs. The cleanliness is controlled to parts-per-billion (ppb) levels and the resonator is sealed at the wafer level using a MEMS Epi-Seal™ process.

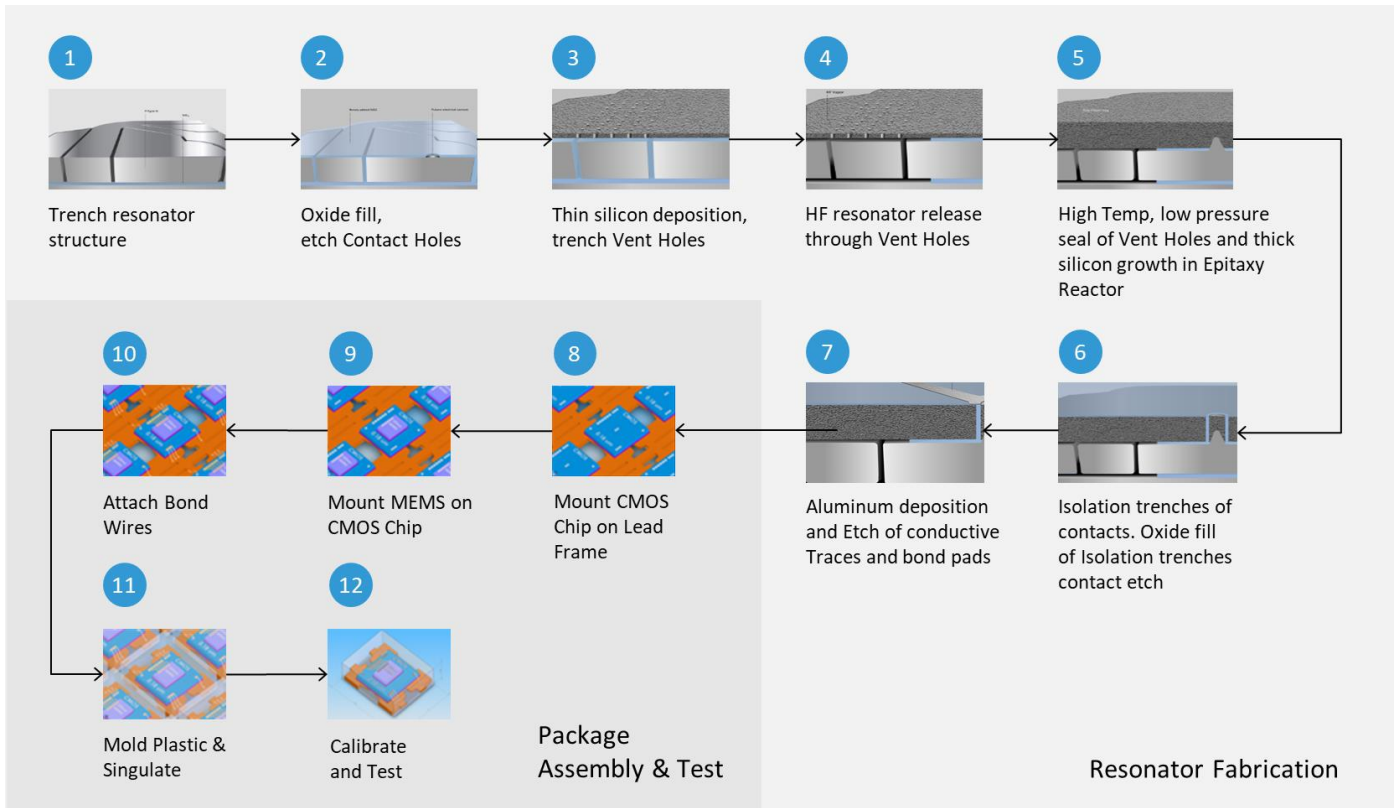

Figure 2. SiTime MEMS Oscillator Manufacturing Process Flow

This ultra-clean fabrication process results in the industry’s best quality and reliability. Figure 3 shows mean time between failure (MTBF) of 1.9 billion hours for SiTime MEMS oscillators vs. two quartz vendors who reported 38 million hours and 28 million hours respectively. While 38 million hours may seem adequate, applying this MTBF to 10,000 shipped systems in one year will result in a measurable 2.3 failures per year. In contrast, the SiTime MEMS MTBF of 1.9 billion hours corresponds to only 0.04 failures per year or only a 4% chance of 1 failure in one year as shown in Figure 4.

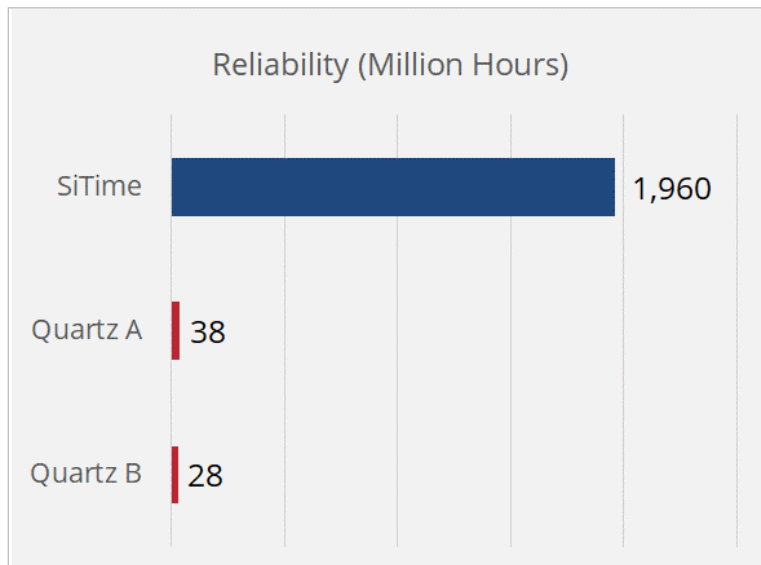

Figure 3. SiTime MEMS versus Quartz Oscillator MTBF Comparison

Vendor	MTBF (Million hours)	Predicted Failures per Year per 10,000 Units
SiTime	1,960	0.04
Quartz A	38	2.3
Quartz B	28	3.1

Figure 4. SiTime MEMS versus Quartz Oscillators: Predicted Failures per Year per 10,000 Units

Part 2. “Simply Built” - Device Architecture Differences

SiTime MEMS oscillators use phase locked loop (PLL) technology as do quartz oscillator vendors, such as Epson with the SG-8018 and SG-8002 oscillators. The Epson SG-8018 oscillator datasheet lists 68 ps of phase jitter (12 kHz to 20 MHz), which is over 4x worse than the “Si-MEMS1” oscillator referenced in the Epson white paper. Surface acoustic wave (SAW) resonators such as the Epson EG-2121 will be compared with SiTime MEMS oscillators, SiT9501 and SiT9365 later in this paper. The key point is there is no single architecture which defines an oscillator. Oscillators have individual architectures with different power-performance characteristics targeting different applications.

The architecture of the SiT9501 differential output oscillator is shown in Figure 5. It uses an integer PLL with a MEMS resonator and temperature compensation circuitry. While the PLL and temperature compensation circuitry do have a power cost, these architectural components deliver higher performance and great flexibility. Among the benefits related to these features:

- Programmable output frequency enables flexibility and fast lead times. Quartz oscillators that do not use PLLs must use a different quartz resonator for each frequency. This results in complicated logistics, exacerbated by the relatively long lead time to manufacture quartz blanks and the constrained ceramic package supply chain. SiTime MEMS oscillators use a single MEMS resonator, and the output frequency is programmed on-demand after assembly resulting in much shorter lead time and simplified logistics.
- Programmable output format, voltage swing, and DC Levels (FlexSwing™) enables optimized signal integrity and supports all chipsets that use differential clock inputs.
- Temperature compensation enables ± 20 ppm oscillators across extended temperature range of -40°C to 105°C , as well as best-in-class short-term frequency stability.

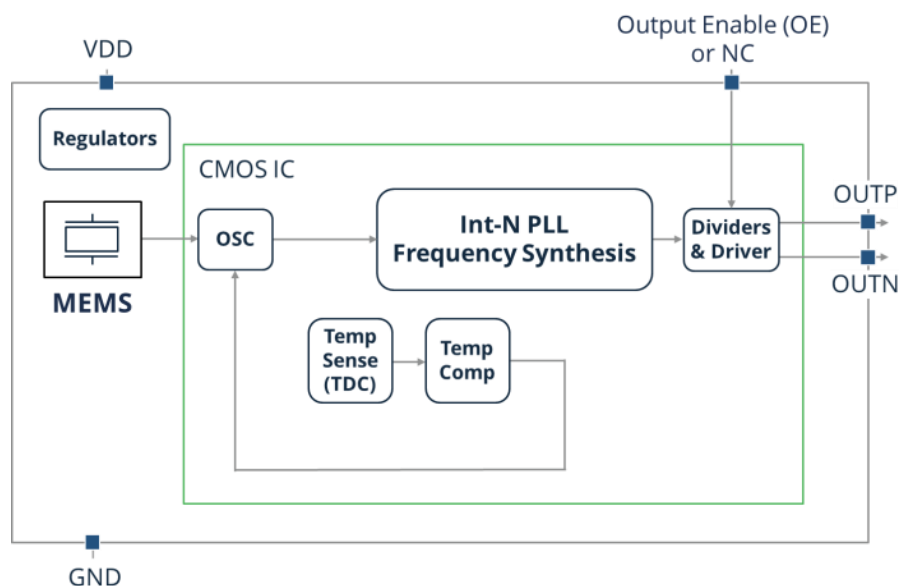

Figure 5. SiTime SiT9501 Architecture

Part 3. Lower Jitter

Another Epson claim is that simple fundamental mode quartz architecture delivers lower jitter than PLL-based devices. To prove this point, Epson showed phase noise and jitter examples of SiTime devices from 2011. Today, the SiTime family of differential output oscillators has significantly improved PLL performance resulting in significantly lower jitter. Figure 6 shows a phase noise plot of the SiT9501 oscillator at 156.25 MHz with only 0.075 ps of integrated phase jitter (IPJ) integrating from 12 kHz to 20 MHz. This is a major improvement over previous generation MEMS oscillators and significantly exceeds the performance requirements of many applications. It also exceeds the performance of the quartz-based SG-210S*B mentioned in the Epson white paper (0.320 ps at 25 MHz), has 4.3x lower/better jitter than the Epson SG-210*B and 3x lower maximum jitter than the Epson EG-2121.

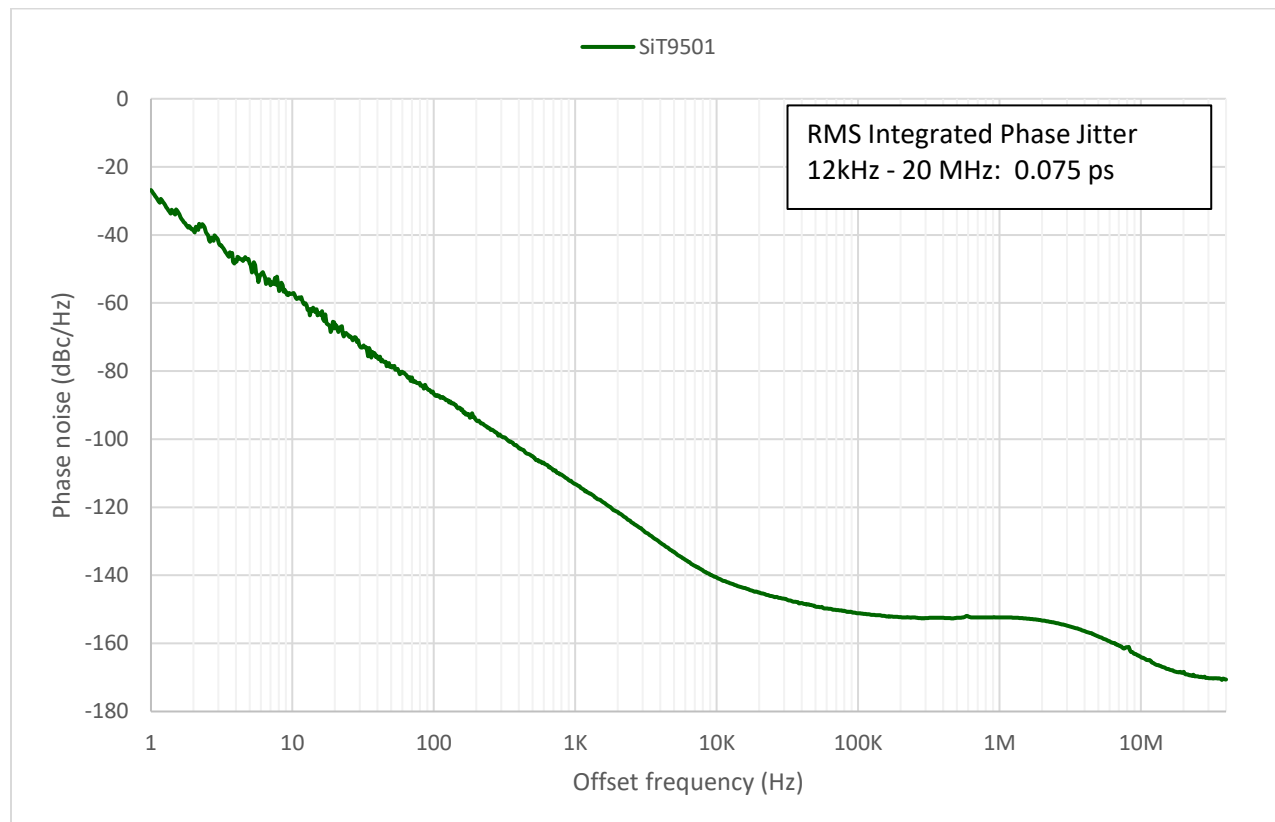

Figure 6. SiTime SiT9501 Phase Noise, 156.25 MHz Output Frequency

Jitter Under Vibration

For some applications, it is important to maintain good performance in the presence of environmental stressors such as vibration. MEMS resonators excel in vibration resistance because of much lower mass than their quartz and SAW counterparts. The mass of quartz resonators ranges from 1000x to 3000x higher than MEMS resonators and this means the resultant force on a MEMS resonator from a given

acceleration will be much lower. Figure 7 overlays the phase noise performance of the SiTime SiT9365 MEMS oscillators with quartz oscillators from Epson, TI, and Pericom under the influence of random vibration of magnitude 7.5g rms and vibration frequency range 15 MHz to 2 kHz. The integrated phase jitter of each oscillator (integration range 10 Hz to 10 kHz) is shown with and without vibration. There was no significant increase in integrated phase jitter on the SiT9365 oscillator, but quartz oscillators show large jitter increases ranging from 2.5x to 6x higher. The Epson SG-7050 oscillator showed an increase from 0.97 ps to 4.6 ps, an increase of 3.8x higher.

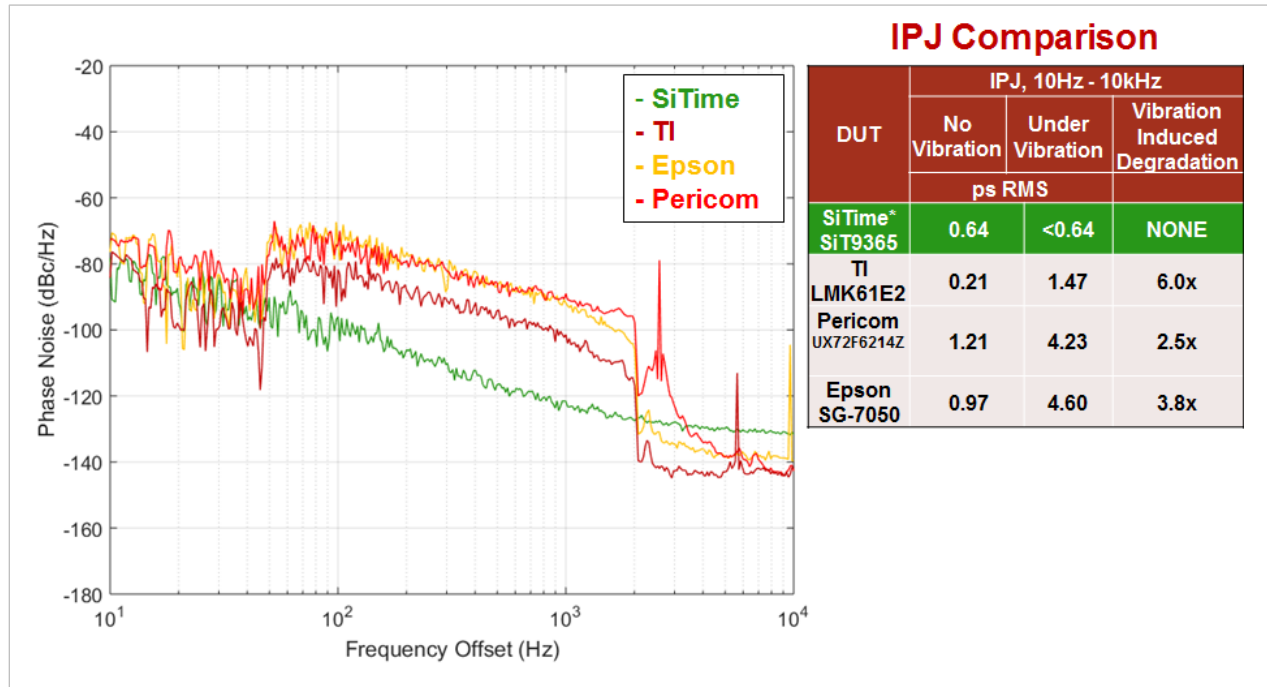

Figure 7. Phase Noise and Integrated Phase Jitter under Random Vibration

Jitter in the Presence of Power Supply Noise

Another common environmental stressor is electrical noise which couples onto the oscillator power supply. Common noise sources are DC-DC converters and linear regulators. A measure of the resilience to this electrical noise is known as power supply noise rejection (PSNR). This is tested by AC-coupling a 50-mV sinusoidal signal at various frequencies onto the oscillator power supply pin and measuring the impact on jitter at the clock output. Lower PSNR numbers in units of picoseconds per millivolt (ps/mV) are indicative of lower jitter and better performance.

Figure 8 compares PSNR for the SiTime MEMS SiT9501 oscillator compared to an Epson quartz EG-2121 oscillator. The SiT9501 performs significantly better across the range of common switching regulator frequencies 200 kHz to 2 MHz: 8.6x lower/better at 200 kHz and 40x better at 2 MHz which is a common DC-DC converter switching frequency.

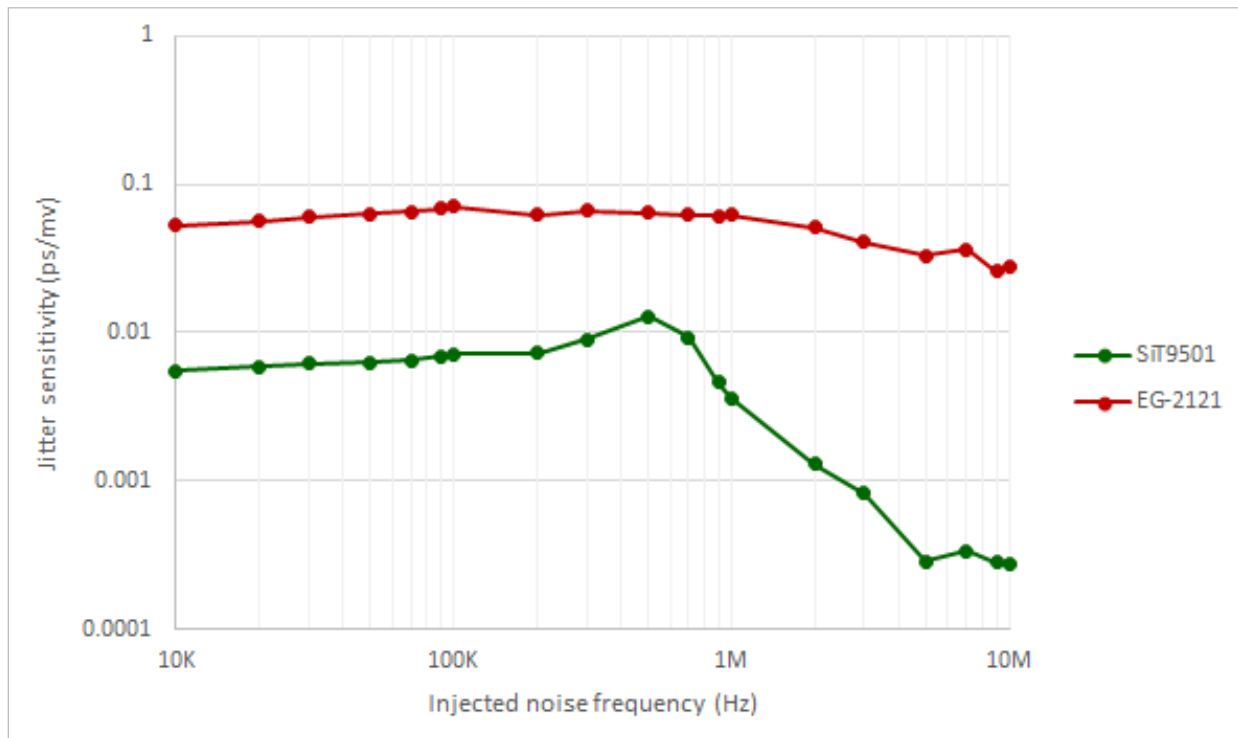

Figure 8. Power Supply Noise Rejection (PSNR)

Part 4. Lower Power Consumption

The latest SiTime differential oscillators are lower power than competing quartz and SAW-based oscillators including the Epson EG-2121. In PLL design, it is possible to trade-off jitter performance for lower power, and SiTime offers other product families with significantly lower power than most fundamental mode oscillators. Table 1 lists power consumption of several SiTime and Epson oscillators.

Product	Max IDD	Notes
SiTime SiT9501, 156.25 MHz	48.4 mA	MEMS and PLL based oscillator. Best frequency stability over temperature and short-term frequency stability (STFS)
Epson EG-2121, 156.25 MHz	80 mA	SAW oscillator, no PLL. Worse frequency stability over temperature and short-term frequency stability (STFS)
SiTime SiT8021, 25 MHz	0.32 mA	MEMS oscillator with PLL optimized for low power consumption
Epson SG-210S*B, 25 MHz	1.6 mA	Quartz fundamental mode oscillator (No PLL)

Table 1. Power Consumption

The SiT9501 and EG-2121 devices are both high performance oscillators with low jitter and capable of high frequency. The SiT9501 has a PLL for programmable output frequency and temperature compensation and consumes 48.4 mA maximum – 39.5% lower than the Epson EG-2121 SAW based oscillator. SiTime has made great strides in lowering PLL power while maintaining excellent jitter performance, surpassing the performance of the EG-2121.

The Epson SG-210S*B is in a lower performance class (worse jitter) than the Epson EG-2121, does not have a PLL, and has low power consumption of 1.6 mA. The SiTime SiT8021 oscillator includes a PLL and is optimized with 5x lower IDD than the SG-210S*B. Besides these oscillators, the SiTime portfolio includes a rich selection of oscillators with different power-performance profiles for every application segment as shown in Table 2 below.

Product	IDD (typ.)	Jitter and other notes
SiT9501 156.25 MHz, Differential output	34 mA	Integrated Phase Jitter, 0.1 ps maximum, 12k to 20M
SiT1602 20 MHz, Single-ended output	3.8 mA	Integrated Phase Jitter, 2.0 ps rms maximum, 12k to 20M
SiT8021 20 MHz, Single-ended output	0.25 mA	Period Jitter, 110 ps rms maximum
SiT1576 1 MHz, Single-ended output	0.013 mA	Period Jitter, 4.5 ns rms maximum
SiT1532 32.768 kHz, Single-ended output	0.0014 mA	Period jitter, 35 ns rms maximum

Table 2. SiTime Power-Performance Offerings

Part 5. Better Frequency vs. Temperature

Epson Claim: MEMS oscillators have “jagged” frequency vs. temperature response curve.

While the Epson white paper acknowledged MEMS oscillator superiority in total frequency vs. temperature characteristics, it also mentioned frequency jumps in the frequency vs. temperature curve due to the MEMS temperature compensation circuitry.

Figure 9 shows the frequency vs. temperature characteristic of the SiTime SiT9501 vs. the Epson EG-2121. As shown in the plot, the SiTime SiT9501 has almost 10x lower (better) frequency variation over temperature due to temperature compensation and a smooth profile with no frequency jumps or jaggedness. Our recent oscillator products demonstrate significantly improved temperature compensation with high order polynomial curve fit and a high-bandwidth temperature-to-digital converter (TDC).

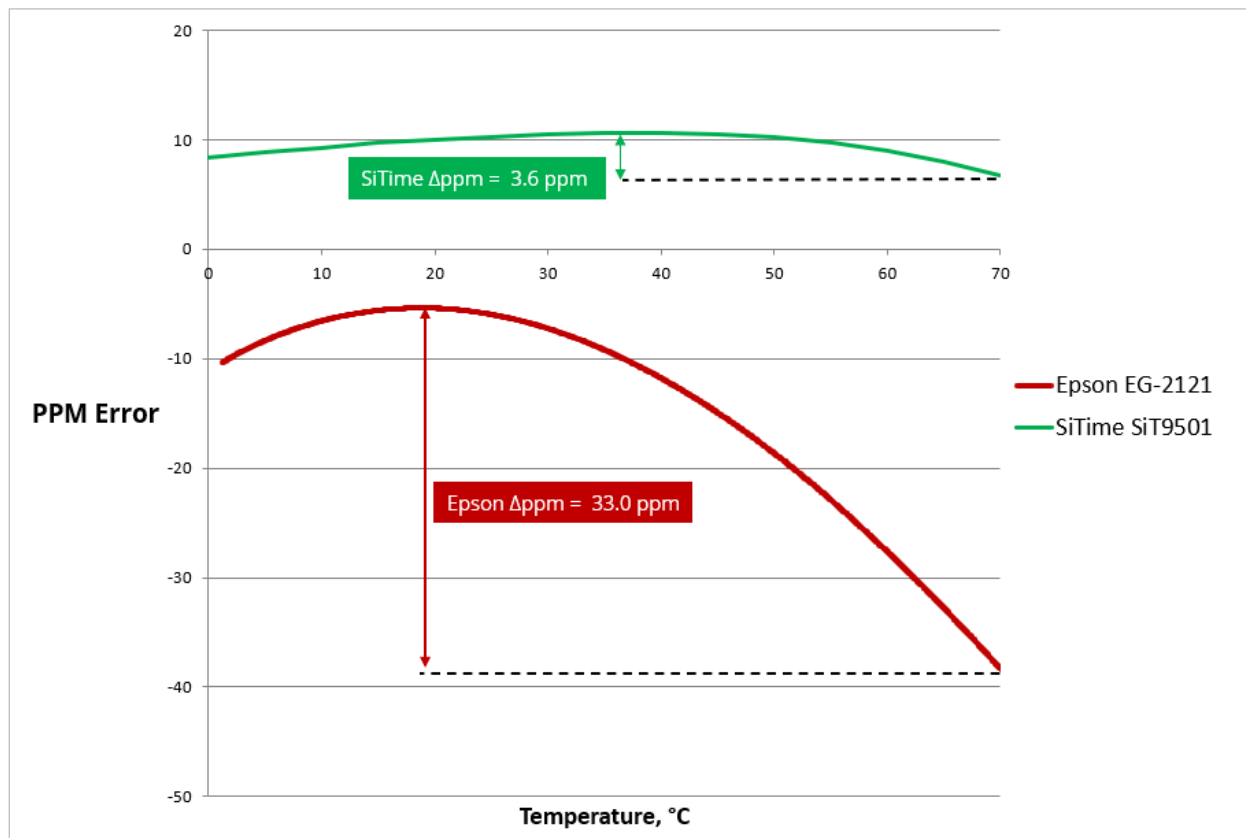

Figure 9. Frequency vs. Temperature

Part 6. Better Short-Term Frequency Stability

Epson Claim: MEMS oscillators have worse short-term frequency stability.

The MEMS-based SiT9501 oscillator incorporates temperature compensation techniques which deliver outstanding frequency stability over temperature. This temperature compensation circuitry is available in SiTime XOs, VCXOs, and TCXOs, with TCXOs having the best temperature stability performance.

Temperature compensation improves short term frequency stability because even very small temperature changes over short time intervals impact the output frequency and hence short-term frequency stability.

Figure 10 shows short term frequency stability of the SiTime SiT9501 differential XO vs. the Epson EG-2121 XO. As shown in the plot, the overall deviation of the SiT9501 is much lower than the Epson oscillator, primarily due to the temperature compensation which is built in to all SiTime oscillators. Quartz and SAW based oscillators do not typically have built-in temperature compensation. The maximum deviation of the SiTime oscillator is 6 ppb vs. 22 ppb for the Epson oscillator over the 50-second interval.

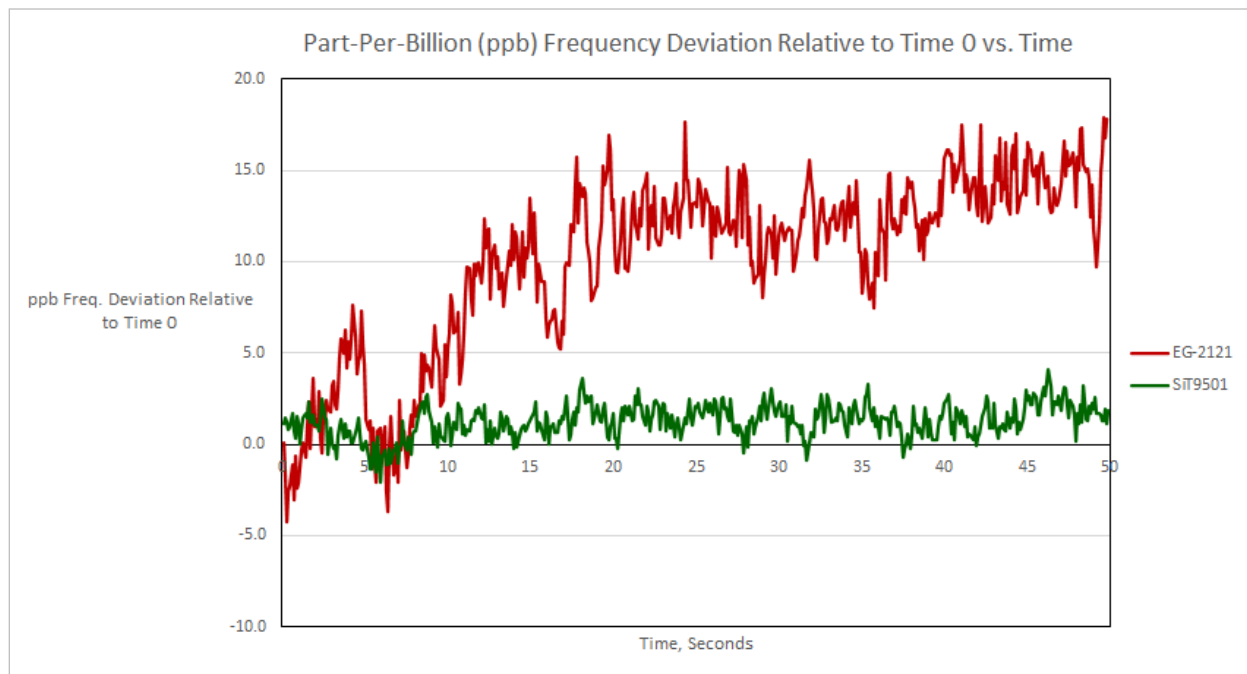

Figure 10. Short Term Frequency Stability – Raw Frequency Data

Another means of characterizing short term stability (besides showing raw frequency data as shown in the previous plot) is using statistical means such as Allan variance/deviation. Allan variance is proportional to the sum of squares difference between fractional frequency deviations of adjacent frequency samples in time. Allan deviation is simply the square root of Allan variance. This is somewhat

analogous to standard variance/standard deviation, but Allan variance is a two-sample variance – each sample is compared to the previous sample rather than the mean value of the population as in standard deviation. The averaging interval for these adjacent frequency samples is usually labeled as τ . The formula for Allan deviation is as follows:

$$\sigma_y(\tau) = \sqrt{\frac{1}{2(M-1)} \sum_{i=1}^{M-1} (y_{i+1} - y_i)^2}$$

Since $\sigma_y(\sigma)$ is a measure of short-term frequency instability, lower numbers represent better performance. When we calculate the Allan variation of this frequency trend data, we obtain the plots shown in Figure 11 which shows Allan deviation vs. frequency sample averaging time.

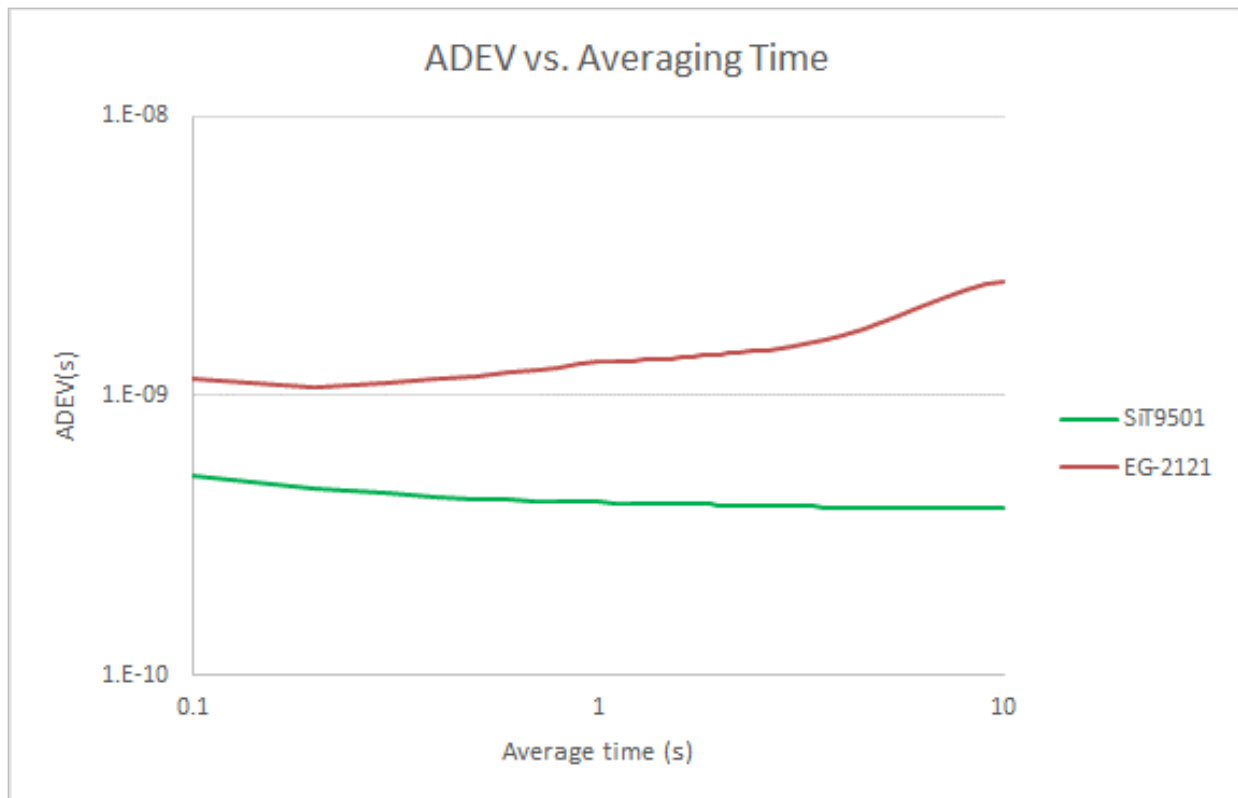

Figure 11. Allan Deviation vs. Sample Averaging Time τ

As seen from the Allan deviation plot (and seen intuitively in the frequency trend data in Figure 10), the SiTime SiT9501 oscillator has much better performance than the Epson EG-2121 oscillator. At an averaging time of 10 sec, the SiTime SiT9501 has about 6x lower/better ADEV than the Epson EG-2121.

Conclusion

This white paper has discussed several important performance metrics for oscillators including phase noise and phase jitter, power consumption, frequency stability and power supply noise rejection.

Table 3 summarizes the performance comparison between a MEMS-based SiT9501 and a quartz-based EG-2121. In every category, the SiTime MEMS technology, as demonstrated by the SiT9501, significantly exceeds that of the Epson EG-2121.

Parameter	SiTime SiT9365	Epson	Notes
Max Integrated Phase Jitter, 156.25 MHz, 12k-20M	100 fs	300 fs	SiTime 3x lower/better. Enables higher bandwidth and lower Bit Error Rate (BER).
Maximum Supply Current	48.4 mA	80 mA	SiTime almost 60% current of Epson.
Supply Voltage Options	3.3V, 2.5V, 1.8V	2.5V	SiTime offers flexible supply voltage options and lowest 1.8V option offers significant power savings vs. 2.5V.
Maximum Operating Power	121 mW	200 mW	SiTime almost ½ power of Epson. Saves OPEX and lowers system heating.
LVPECL Output	121 mW	200mW	SiTime almost ½ power of Epson. Saves OPEX and lowers system heating.
Maximum Start-Up Time	5 msec	10 msec	SiTime 2x faster/better
Frequency Stability	±20 ppm	±50 ppm	SiTime 2.5x lower/better
Operating Temperature	-40°C to 105°C	-5°C to 85°C	Most non-consumer applications require industrial -40°C to 85°C or better. SiTime -40°C to 105°C support is important for harsh environments.
PSNR @ 2,000 kHz, 50 mV Injected Noise	0.00129 ps/mV	0.05133 ps/mV	SiTime almost 40x lower/better which enables operation in systems which have significant electrical noise.

Table 3. Performance Comparison Between SiTime SiT9501 and Epson EG-2121

Table 4: Revision History

Version	Release Date	Change Summary
1.0	11-Aug-19	Original doc
1.1	3-Jan-23	Inclusion of SiT9501 data. Edits for clarity.

SiTime Corporation, 5451 Patrick Henry Drive, Santa Clara, CA 95054, USA | **Phone:** +1-408-328-4400 | **Fax:** +1-408-328-4439

© SiTime Corporation, December 2022 The information contained herein is subject to change at any time without notice. SiTime assumes no responsibility or liability for any loss, damage or defect of a Product which is caused in whole or in part by (i) use of any circuitry other than circuitry embodied in a SiTime product, (ii) misuse or abuse including static discharge, neglect or accident, (iii) unauthorized modification or repairs which have been soldered or altered during assembly and are not capable of being tested by SiTime under its normal test conditions, or (iv) improper installation, storage, handling, warehousing or transportation, or (v) being subjected to unusual physical, thermal, or electrical stress.

Disclaimer: SiTime makes no warranty of any kind, express or implied, with regard to this material, and specifically disclaims any and all express or implied warranties, either in fact or by operation of law, statutory or otherwise, including the implied warranties of merchantability and fitness for use or a particular purpose, and any implied warranty arising from course of dealing or usage of trade, as well as any common-law duties relating to accuracy or lack of negligence, with respect to this material, any SiTime product and any product documentation. Products sold by SiTime are not suitable or intended to be used in a life support application or component, to operate nuclear facilities, or in other mission critical applications where human life may be involved or at stake. All sales are made conditioned upon compliance with the critical uses policy set forth below.

CRITICAL USE EXCLUSION POLICY

BUYER AGREES NOT TO USE SITIME'S PRODUCTS FOR ANY APPLICATION OR IN ANY COMPONENTS USED IN LIFE SUPPORT DEVICES OR TO OPERATE NUCLEAR FACILITIES OR FOR USE IN OTHER MISSION-CRITICAL APPLICATIONS OR COMPONENTS WHERE HUMAN LIFE OR PROPERTY MAY BE AT STAKE.

SiTime owns all rights, title and interest to the intellectual property related to SiTime's products, including any software, firmware, copyright, patent, or trademark. The sale of SiTime products does not convey or imply any license under patent or other rights. SiTime retains the copyright and trademark rights in all documents, catalogs and plans supplied pursuant to or ancillary to the sale of products or services by SiTime. Unless otherwise agreed to in writing by SiTime, any reproduction, modification, translation, compilation, or representation of this material shall be strictly prohibited.