	<b>Title:</b>	Performance Report SiT9120, 212.5MHz		
	<b>Type:</b>	Performance report	<b>Rev:</b>	1.0
	<b>Orig:</b>		<b>Date:</b>	May 07, 2012

**This report contains sample performance data for SiT9120 - 212.5MHz with LVPECL output.**

**Conditions:**

- Frequency 212.5 MHz
- Vdd 2.5V, 3.3V
- Room temperature
- Termination:
  - o 50Ω to Vdd – 2V.

**Equipment:**

Equipment	Measurement / Purpose
Agilent DSA90604A (6GHz, 20Gsps)	Period jitter, Differential voltage swing, Rise/fall time
Agilent 5052B Signal Source Analyzer	Phase noise, integrated phase jitter
Agilent 34980A	Power supply current
Agilent E3631A, Agilent E3648A	Power supplies

**Test setup:**

The test setup for measuring period jitter and waveform parameters is shown in Figure 1. In this setup the devices VDD pin is connected to 2V and GND pin to 2V – Vnom, where Vnom is the nominal VDD for the device (2.5V or 3.3V). This allows terminating the outputs directly to the 50ohm-to-GND termination inside the scope with 50ohm coax cables.

Differential measurement with oscilloscope:

For jitter measurements, both DUT outputs are connected to scope channels. Signals from inputs are subtracted inside the oscilloscope. All measurements are applied to the differential waveform.

Phase noise.

For phase noise measurements, differential signal is converted to single-ended using impedance matching transformer.

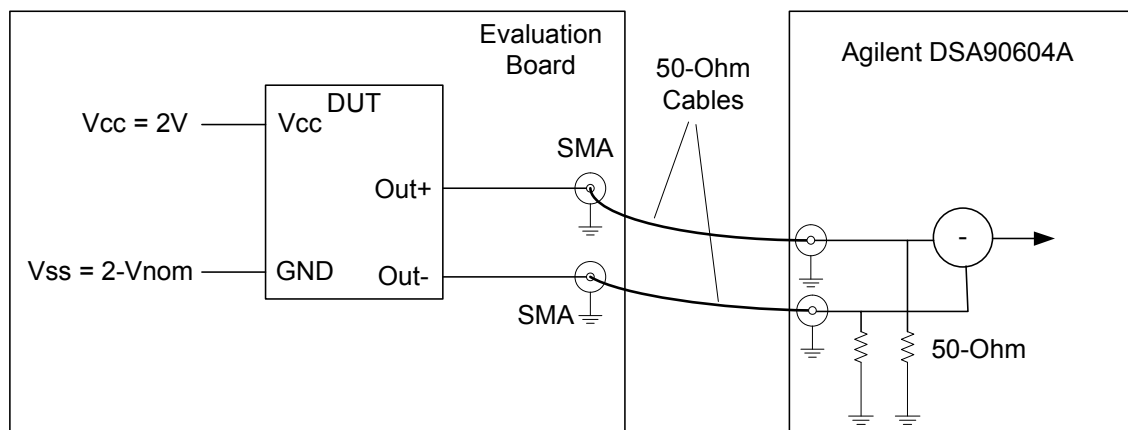

	<b>Title:</b>	Performance Report SiT9120, 212.5MHz		
	<b>Type:</b>	Performance report	<b>Rev:</b>	1.0
	<b>Orig:</b>		<b>Date:</b>	May 07, 2012

Figure 1. Test setup #1 for measuring period jitter, waveform parameters (rise/fall times, differential swing) and IDD.

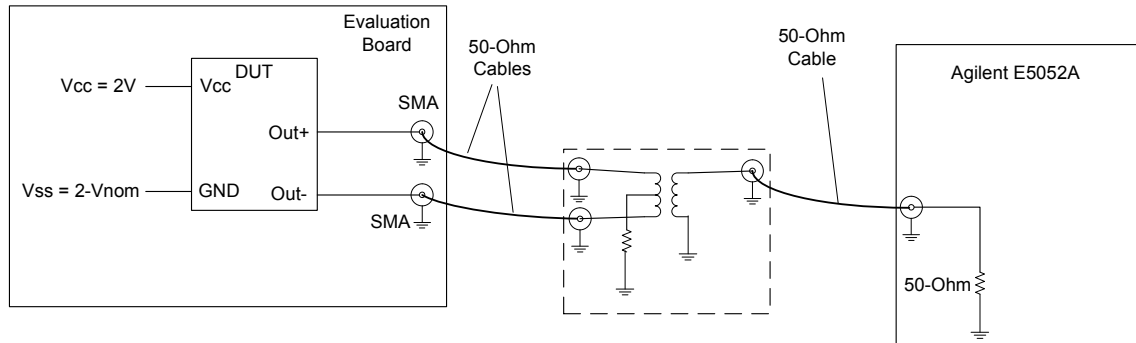



Figure 2. Test setup #2 for measuring phase noise.

**Data:**

- Random Phase jitter
- Period jitter
- Idd

Parameter	Units	Voltage	
		2.5V	3.3V
Random Phase jitter (12kHz - 20MHz)	ps, rms	0.55	0.57
Period jitter	ps, rms	1.06	1.01
Current consumption (no load)	mA	53.4	53.4

Table 1. Performance data

	<b>Title:</b>	Performance Report SiT9120, 212.5MHz		
	<b>Type:</b>	Performance report	<b>Rev:</b>	1.0
	<b>Orig:</b>		<b>Date:</b>	May 07, 2012

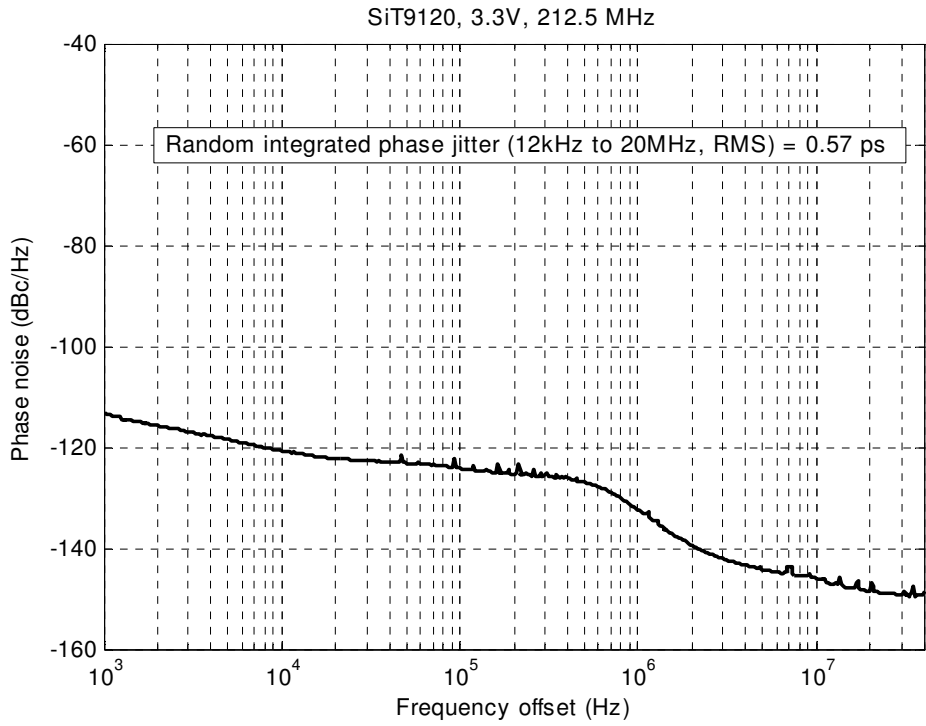



Figure 3. Phase noise plot 3.3V

**The information contained in this document is confidential and proprietary to SiTime Corporation. Unauthorized reproduction or distribution is prohibited.**

	<b>Title:</b>	Performance Report SiT9120, 212.5MHz		
	<b>Type:</b>	Performance report	<b>Rev:</b>	1.0
	<b>Orig:</b>		<b>Date:</b>	May 07, 2012

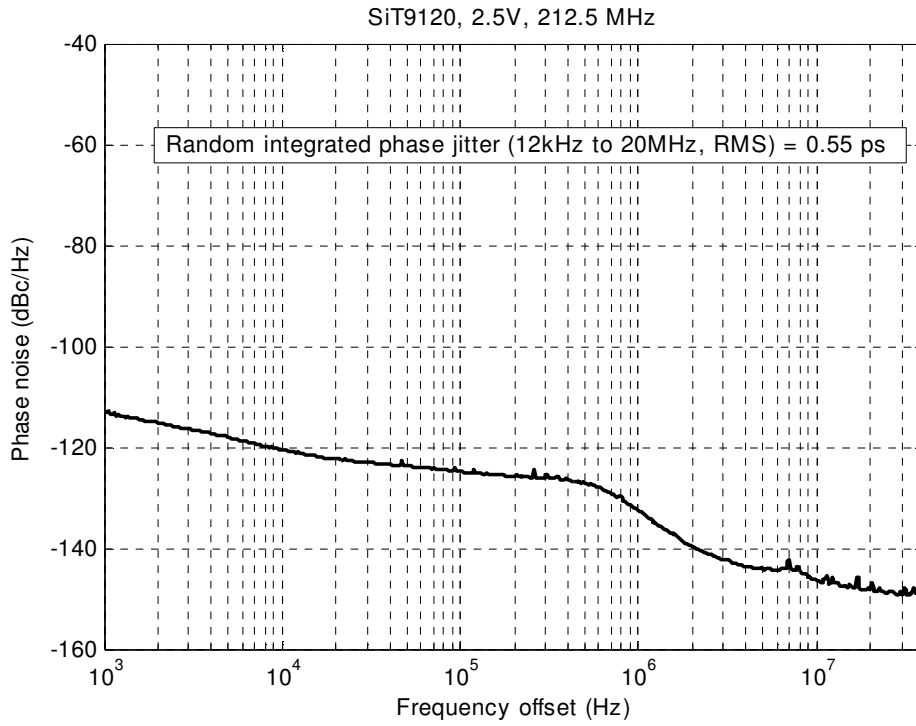



Figure 4. Phase noise plot 2.5V

	<b>Title:</b>	Performance Report SiT9120, 212.5MHz		
	<b>Type:</b>	Performance report	<b>Rev:</b>	1.0
	<b>Orig:</b>		<b>Date:</b>	May 07, 2012

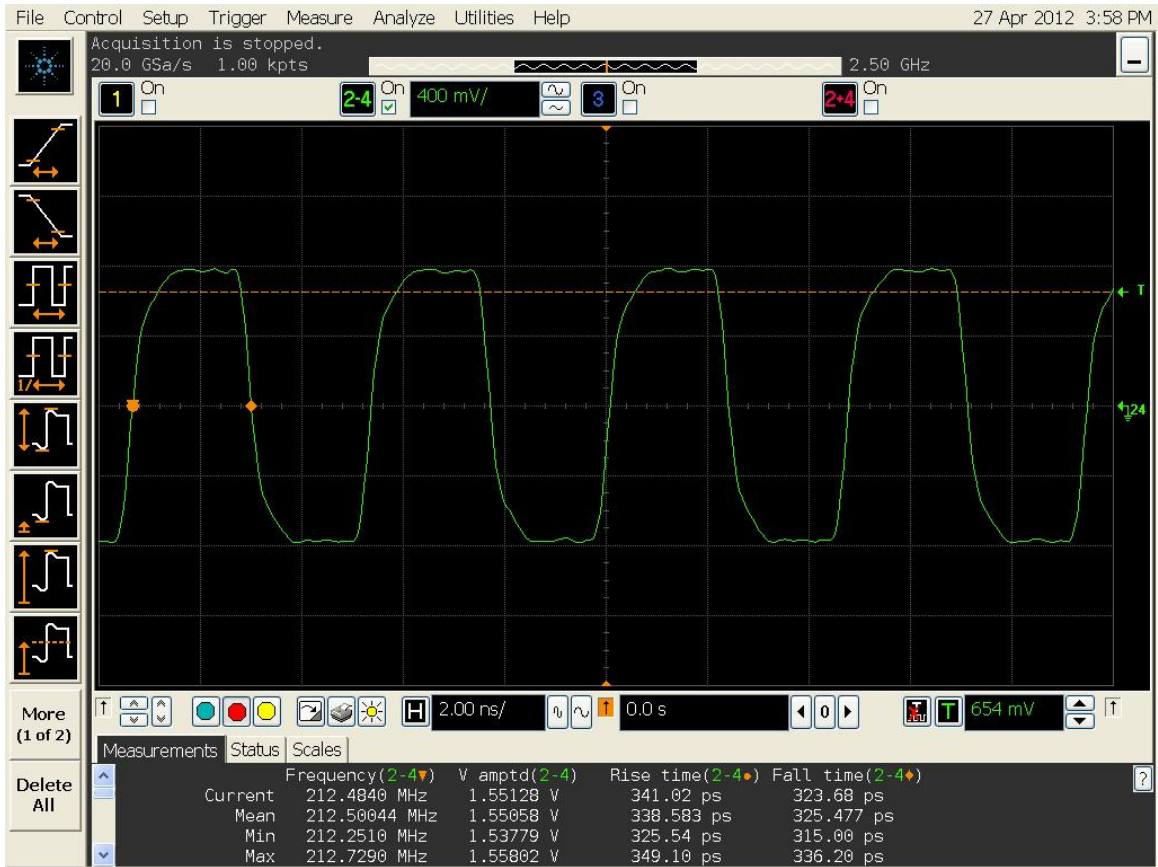



Figure 5. Waveform 3.3V

	<b>Title:</b>	Performance Report SiT9120, 212.5MHz		
	<b>Type:</b>	Performance report	<b>Rev:</b>	1.0
	<b>Orig:</b>		<b>Date:</b>	May 07, 2012

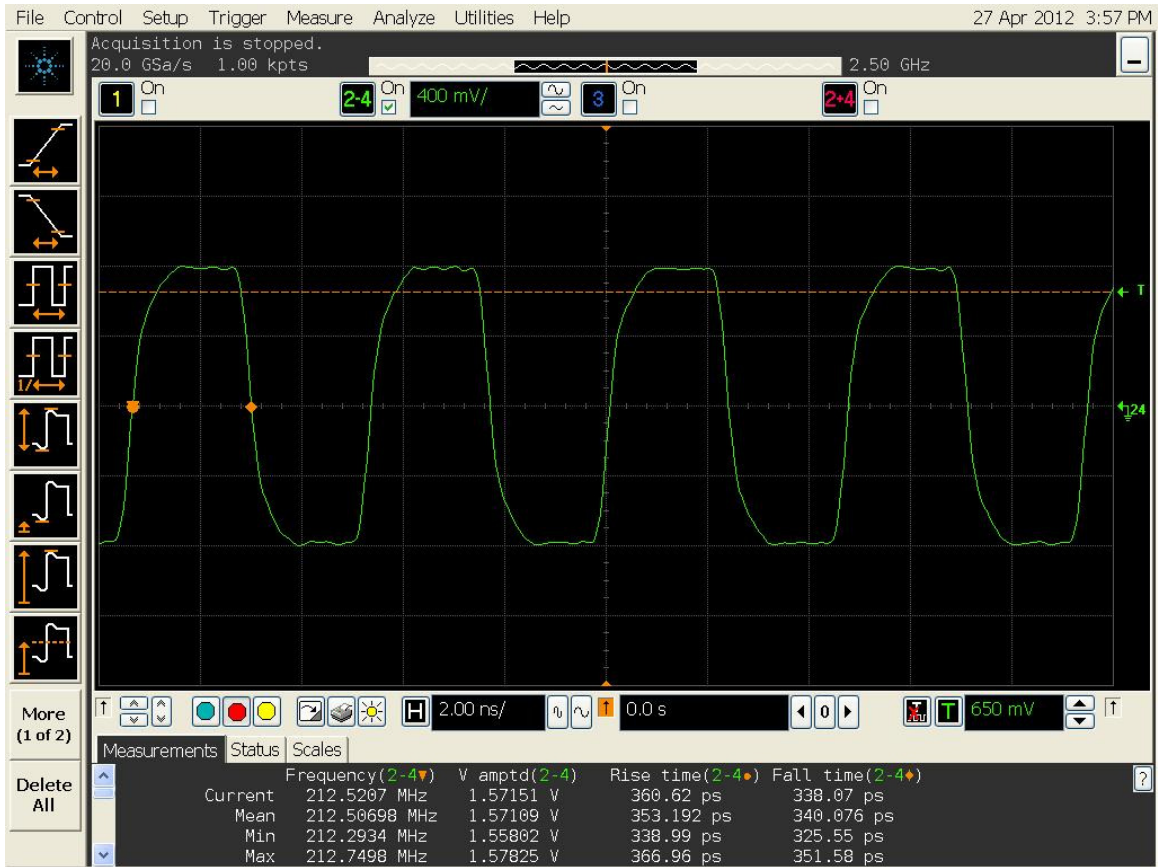

Figure 6. Waveform 2.5V