	Title:	Performance Report SiT9120, 148.5MHz		
	Type:	Performance report	Rev:	1.0
	Orig:		Date:	May 07, 2012

This report contains sample performance data for SiT9120 - 148.5MHz with LVDS output.

Conditions:

- Frequency 148.5 MHz
- Vdd 2.5V, 3.3V
- Room temperature
- Termination:
 - o 100Ω between both outputs; AC coupled.

Equipment:

Equipment	Measurement / Purpose
Agilent DSA90604A (6GHz, 20Gsps)	Period jitter, Differential voltage swing, Rise/fall time
Agilent 5052B Signal Source Analyzer	Phase noise, integrated phase jitter
Agilent 34980A	Power supply current
Agilent E3631A	Power supply

Test setup:

The test setup for measuring period jitter and waveform parameters is shown in Figure 1. In this setup both DUT outputs are AC coupled and connected to oscilloscope inputs by 50-ohm coax cables.

Differential measurement with oscilloscope:

For jitter measurements, both DUT outputs are connected to scope channels. Signals from inputs are subtracted inside the oscilloscope. All measurements are applied to the differential waveform.

Phase noise.

For phase noise measurements, differential signal is converted to single-ended using impedance matching transformer.

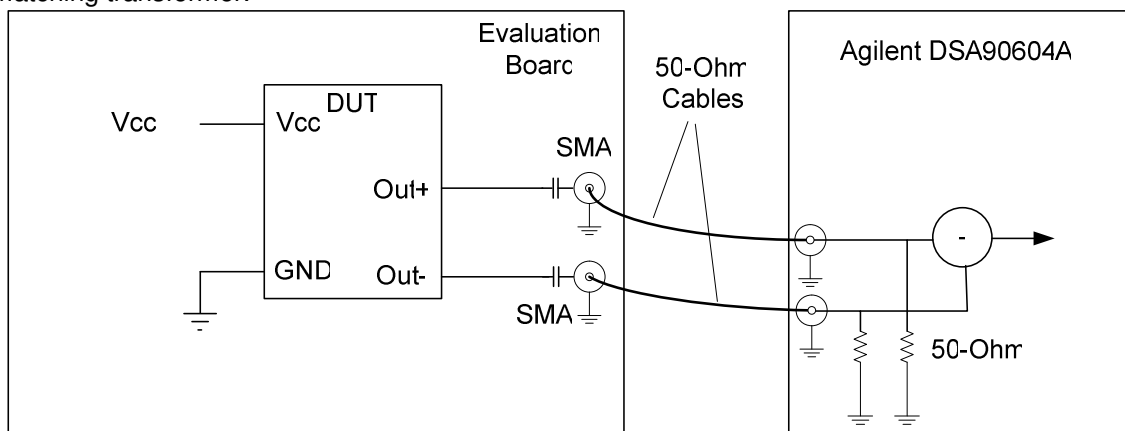



Figure 1. Test setup #1 for measuring period jitter, waveform parameters (rise/fall times, differential swing) and IDD.

	Title:	Performance Report SiT9120, 148.5MHz		
	Type:	Performance report	Rev:	1.0
	Orig:		Date:	May 07, 2012

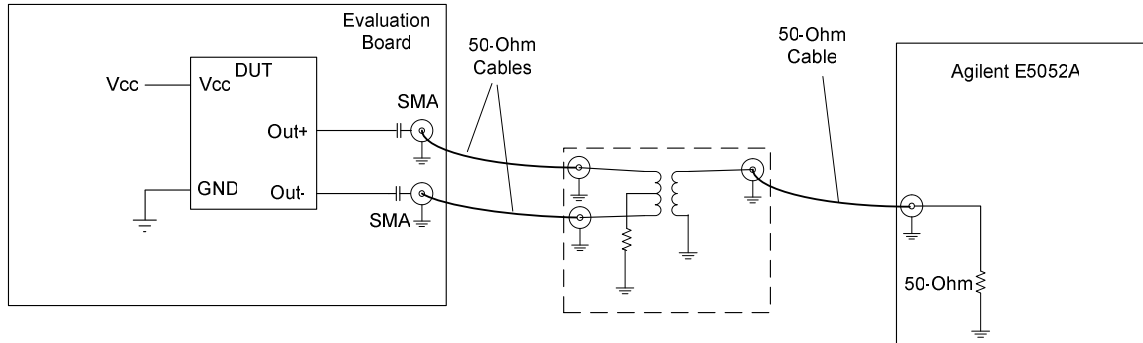



Figure 2. Test setup #2 for measuring phase noise.

Data:

- Random Phase jitter
- Period jitter
- Idd

Parameter	Units	Voltage	
		2.5V	3.3V
Random Phase jitter (12kHz - 20MHz)	ps, rms	0.54	0.55
Period jitter	ps, rms	1.31	1.24
Current consumption (no load)	mA	44.4	44.4

Table 1. Performance data

	Title:	Performance Report SiT9120, 148.5MHz		
	Type:	Performance report	Rev:	1.0
	Orig:		Date:	May 07, 2012

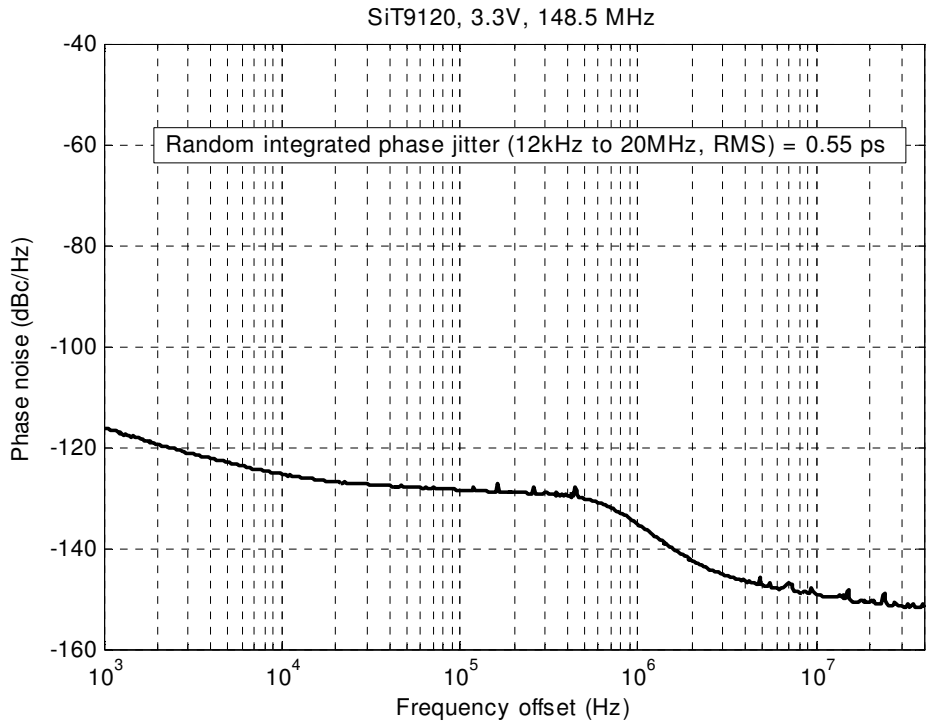



Figure 3. Phase noise plot 3.3V

	Title:	Performance Report SiT9120, 148.5MHz		
	Type:	Performance report	Rev:	1.0
	Orig:		Date:	May 07, 2012

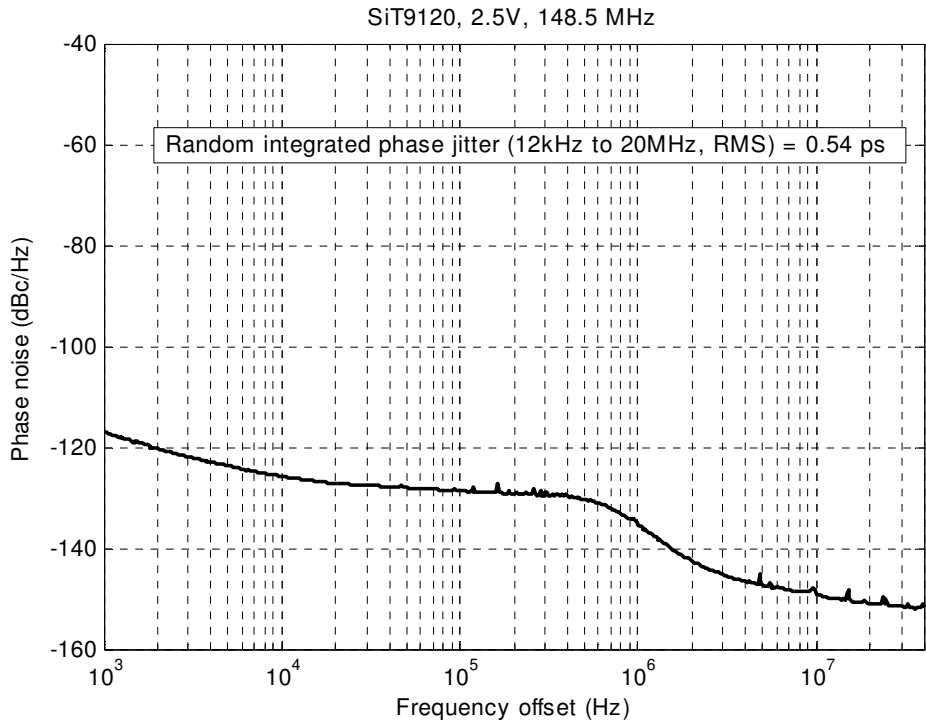



Figure 4. Phase noise plot 2.5V

	Title:	Performance Report SiT9120, 148.5MHz		
	Type:	Performance report	Rev:	1.0
	Orig:		Date:	May 07, 2012

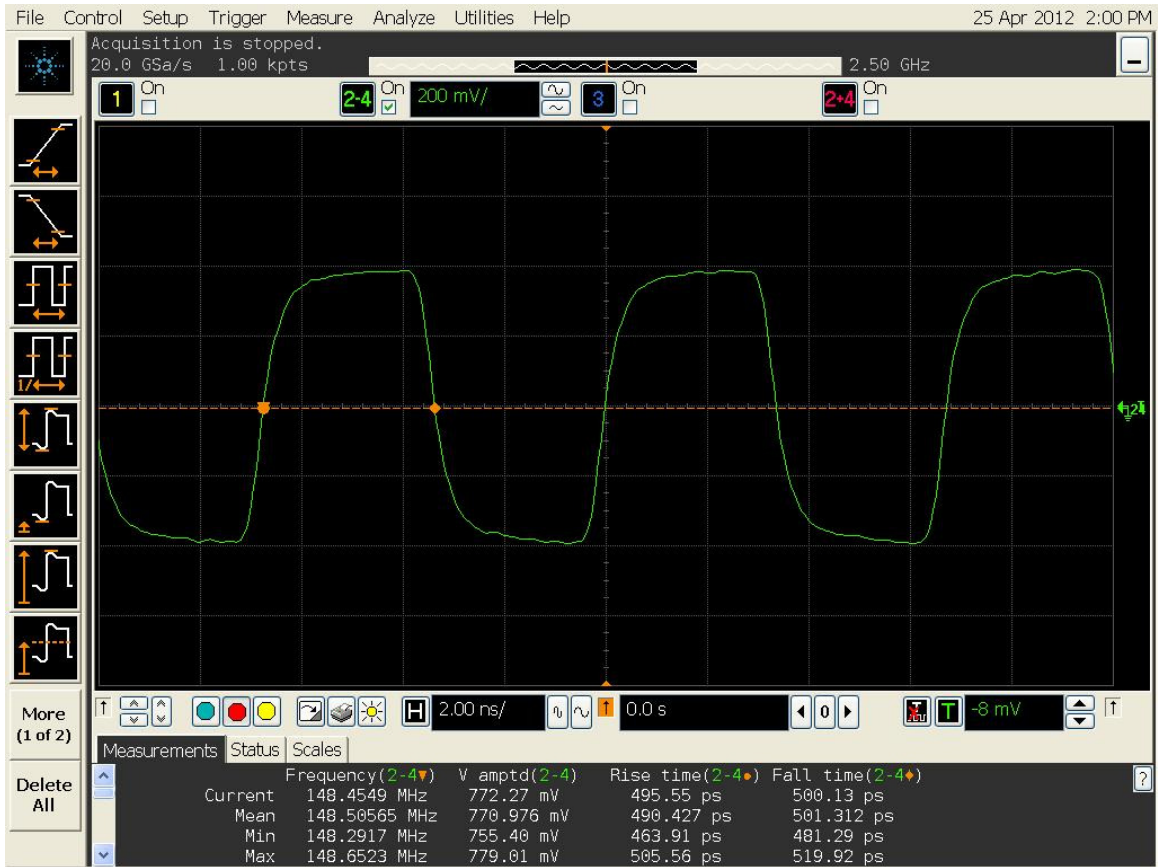

Figure 5. Waveform 3.3V

	Title:	Performance Report SiT9120, 148.5MHz		
	Type:	Performance report	Rev:	1.0
	Orig:		Date:	May 07, 2012



Figure 6. Waveform 2.5V