

# SiT8004 for Video

## Low Power Oscillator for HDMI and Pixel Clock



### ■ Features, Benefits and Applications

- Lowest power, high frequency oscillator with 6.8mA typical active current
- 148.5 MHz and 148.35164 MHz output frequencies for HDMI, pixel clock and other video applications
- LVCMOS/LVTTL compatible output
- Excellent frequency stability over temperature,  $\pm 20$  PPM
- Ultra low standby current, 1.2 $\mu$ A
- Standby or output enable modes
- Four industry-standard packages: 2.5 x 2.0, 3.2 x 2.5, 5.0 x 3.2, 7.0 x 5.0 mm
- Drop-in replacement of quartz
- Ultra short lead time
- All-silicon device with outstanding reliability of 2 FIT (10x improvement over quartz-based devices), enhancing system mean-time-to-failure (MTBF)

### ■ Specifications

#### Electrical Characteristics

Parameter	Symbol	Min.	Typ.	Max.	Unit	Condition
Output Frequency Range	f	–	148.5	–	MHz	
		–	148.35164	–	MHz	
Frequency Stability	F_stab	-20	–	+20	PPM	Inclusive of: Initial stability, operating temperature, rated power, supply voltage change, load change, shock and vibration  $\pm 20$ PPM available in extended commercial temperature only
		-25	–	+25	PPM	
		-50	–	+50	PPM	
Aging	Ag	-1.0	–	1.0	PPM	1st year at 25°C
Operating Temperature Range	T_use	-20	–	+70	°C	Extended Commercial
		-40	–	+85	°C	Industrial
Supply Voltage	Vdd	2.25	2.5	2.75	V	
		2.52	2.8	3.08	V	
		2.97	3.3	3.63	V	
Current Consumption	Idd	–	7.3	8.5	mA	No load condition, f = 148.5 MHz, Vdd = 3.3 V
		–	6.8	7.5	mA	No load condition, f = 148.5 MHz, Vdd = 2.5 V or 2.8 V
Standby Current	I_std	–	2.4	4.3	$\mu$ A	$\overline{ST}$ = GND, Vdd = 3.3 V, Output is Weakly Pulled Down
		–	1.2	2.2	$\mu$ A	$\overline{ST}$ = GND, Vdd = 2.5 or 2.8 V, Output is Weakly Pulled Down
Duty Cycle	DC	40	50	60	%	All Vdds
Rise/Fall Time	Tr, Tf	–	1	2	ns	20% - 80% Vdd=2.5 V, 2.8 V or 3.3 V, 15 pf load
Output Voltage High	VOH	90%	–	–	Vdd	IOH = -4 mA (Vdd = 3.3 V) IOH = -3 mA (Vdd = 2.8 V and Vdd = 2.5 V)
Output Voltage Low	VOL	–	–	10%	Vdd	IOL = 4 mA (Vdd = 3.3 V) IOL = 3 mA (Vdd = 2.8 V and Vdd = 2.5 V)
Output Load	Ld	–	–	15	pF	At 148.5 MHz and max supply voltage. Contact SiTime for higher output load option
Input Voltage High	VIH	70%	–	–	Vdd	Pin 1, OE or $\overline{ST}$
Input Voltage Low	VIL	–	–	30%	Vdd	Pin 1, OE or $\overline{ST}$
Startup Time	T_osc	–	–	10	ms	Measured from the time Vdd reaches its rated minimum value
Resume Time	T_resume	–	3.0	4.0	ms	Measured from the time ST pin crosses 50% threshold
RMS Period Jitter	T_jitt	–	–	4.5	ps	f = 148.5 MHz, Vdd = 2.5 V, 2.8 V or 3.3 V
RMS Phase Jitter (random)	T_phj	–	0.45	–	ps	f = 148.5 MHz, Integration bandwidth = 900 kHz to 7.5 MHz, VDD = 2.5 V, 2.8 V, or 3.3 V

### Specifications (Cont.)

#### Pin Description Tables

Pin #1 Functionality
<b>OE</b>
H or Open: specified frequency output
L: output is high impedance
<b><math>\overline{\text{ST}}</math></b>
H or Open: specified frequency output
L: output is low level (weak pull down). Oscillation stops

Pin Map	
Pin	Connection
1	OE/ $\overline{\text{ST}}$
2	GND
3	CLK
4	VDD

#### Absolute Maximum Table

Attempted operation outside the absolute maximum ratings of the part may cause permanent damage to the part. Actual performance of the IC is only guaranteed within the operational specifications, not at absolute maximum ratings.

Parameter	Min.	Max.	Unit
Storage Temperature	-65	150	°C
VDD	-0.5	4	V
Electrostatic Discharge	–	2000	V
Theta JA (with copper plane on VDD and GND)	–	75	°C/W
Theta JC (with PCB traces of 0.010 inch to all pins)	–	24	°C/W
Soldering Temperature (follow standard Pb free soldering guidelines)	–	260	°C
Number of Program Writes	–	1	NA
Program Retention over -40 to 125 °C, Process, VDD (0 to 3.65 V)	1,000+	–	years

#### Environmental Compliance

Parameter	Condition/Test Method
Mechanical Shock	MIL-STD-883F, Method 2002
Mechanical Vibration	MIL-STD-883F, Method 2007
Temperature Cycle	JESD22, Method A104
Solderability	MIL-STD-883F, Method 2003
Moisture Sensitivity Level	MSL1 @ 260 °C

#### Startup and Resume Timing Diagram

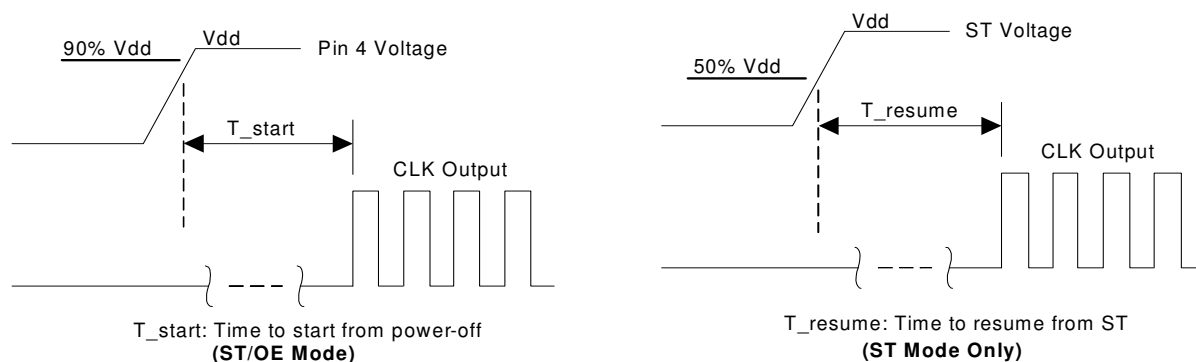

■ Dimensions and Land Patterns

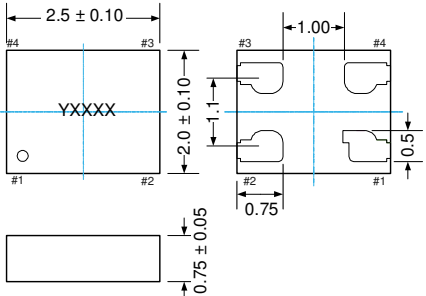
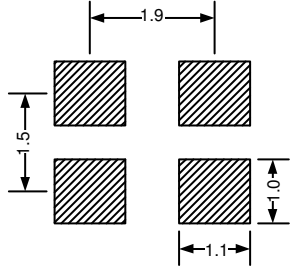
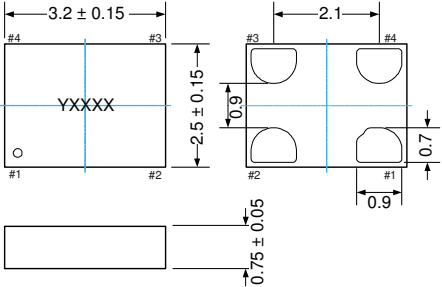
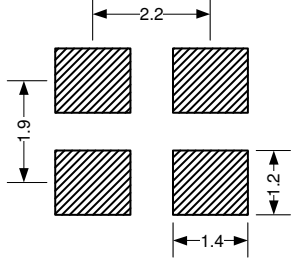
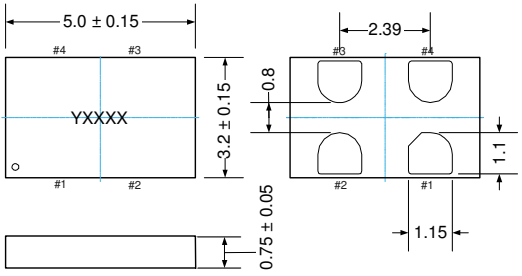
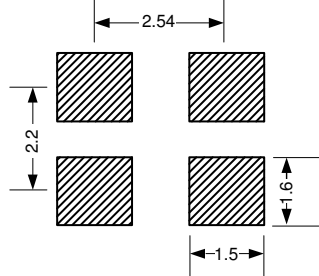
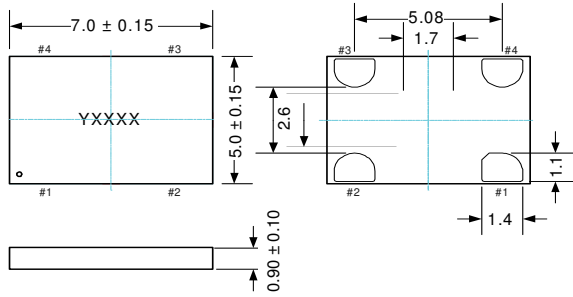
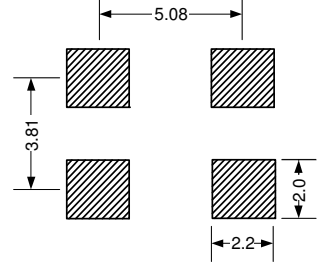
Package Size – Dimensions (Unit: mm) <sup>[2]</sup>	Recommended Land Pattern (Unit: mm) <sup>[3]</sup>
<p><b>2.5 x 2.0 x 0.75 mm</b></p> 	
<p><b>3.2 x 2.5 x 0.75 mm</b></p> 	
<p><b>5.0 x 3.2 x 0.75 mm</b></p> 	
<p><b>7.0 x 5.0 x 0.90 mm</b></p> 	

**Notes:**

1. Y denotes manufacturing origin and XXXX denotes manufacturing lot number. The value of "Y" will depend on the assembly location of the device.
2. A capacitor of value 0.1  $\mu$ F between Vdd and GND is recommended.

# SiT8004 for Video

Low Power Oscillator for HDMI and Pixel Clock HDMI and Video



Part No. Guide - How to Order

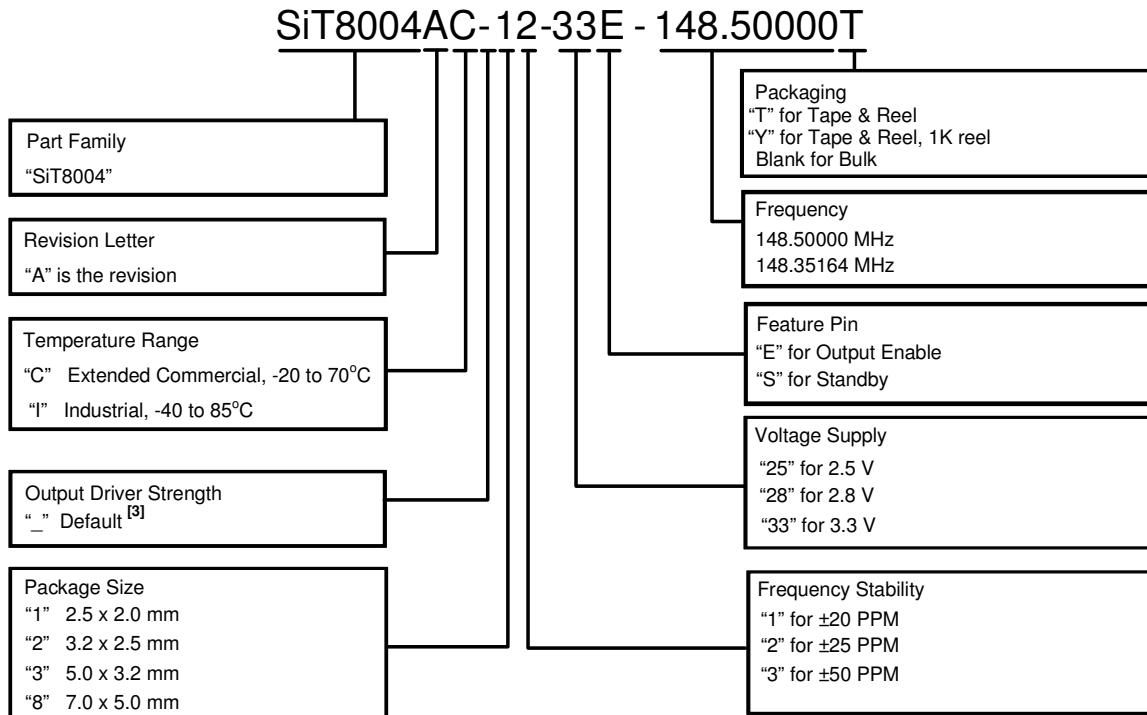

**Note:**

3. Contact SiTime for different drive strength options for driving higher loads or reducing EMI.

**Frequency Stability vs. Temperature Range Options**

Frequency Stability (PPM)	Temperature Range	Supply Voltage		
		2.5 V	2.8 V	3.3 V
±20	C (-20 to +70°C)	✓	✓	✓
	I (-40 to +85°C)	-	-	-
±25	C (-20 to +70°C)	✓	✓	✓
	I (-40 to +85°C)	-	-	-
±50	C (-20 to +70°C)	✓	✓	✓
	I (-40 to +85°C)	-	-	-

© SiTime Corporation 2010. The information contained herein is subject to change at any time without notice. SiTime assumes no responsibility or liability for any loss, damage or defect of a Product which is caused in whole or in part by (i) use of any circuitry other than circuitry embodied in a SiTime product, (ii) misuse or abuse including static discharge, neglect or accident, (iii) unauthorized modification or repairs which have been soldered or altered during assembly and are not capable of being tested by SiTime under its normal test conditions, or (iv) improper installation, storage, handling, warehousing or transportation, or (v) being subjected to unusual physical, thermal, or electrical stress.

**Disclaimer:** SiTime makes no warranty of any kind, express or implied, with regard to this material, and specifically disclaims any and all express or implied warranties, either in fact or by operation of law, statutory or otherwise, including the implied warranties of merchantability and fitness for use or a particular purpose, and any implied warranty arising from course of dealing or usage of trade, as well as any common-law duties relating to accuracy or lack of negligence, with respect to this material, any sitime product and any product documentation. Products sold by sitime are not suitable or intended to be used in a life support application or component, to operate nuclear facilities, or in other mission critical applications where human life may be involved or at stake. All sales are made conditioned upon compliance with the critical uses policy set forth below.

**CRITICAL USE EXCLUSION POLICY**  
BUYER AGREES NOT TO USE SITIME'S PRODUCTS FOR ANY APPLICATION OR IN ANY COMPONENTS USED IN LIFE SUPPORT DEVICES OR TO OPERATE NUCLEAR FACILITIES OR FOR USE IN OTHER MISSION-CRITICAL APPLICATIONS OR COMPONENTS WHERE HUMAN LIFE OR PROPERTY MAY BE AT STAKE.

SiTime owns all rights, title and interest to the intellectual property related to SiTime's products, including any software, firmware, copyright, patent, or trademark. The sale of SiTime products does not convey or imply any license under patent or other rights. SiTime retains the copyright and trademark rights in all documents, catalogs and plans supplied pursuant to or ancillary to the sale of products or services by SiTime. Unless otherwise agreed to in writing by SiTime, any reproduction, modification, translation, compilation, or representation of this material shall be strictly prohibited.